



===== **CONTENTS** =====

1. INTRODUCTION.....	3
2. FEATURES	3
3. PIN ASSIGNMENT.....	3
4. BLOCK DIAGRAM	4
5. FUNCTION DESCRIPTIONS	4
5.1 OSCILLATOR	4
5.2 ROM	4
5.3 RAM	5
5.4 POWER DOWN MODE.....	5
5.5 SAMPLING RATE COUNTER.....	5
5.6 I/O PORTS	5
5.7 PUSH-PULL OUTPUT	6
5.8 WATCH DOG TIMER.....	6
5.9 IR FUNCTION	6
6. ABSOLUTE MAXIMUM RATING	6
7. ELECTRICAL CHARACTERISTICS	7
8. APPLICATION CIRCUIT	8



AMENDMENT HISTORY

Version	Date	Description
Ver 1.3	January 14, 2005	First issue
Ver 1.4	March 17, 2005	Modify Standby & operation current
Ver 1.5	May 25, 2005	Remove APPLICATION CIRCUIT RST pin capacitance Add IR Description



1. INTRODUCTION

SNC12030 is a one-channel voice synthesizer IC with Push-Pull direct drive circuit. It built-in a 4-bit tiny controller with three 4-bit I/O ports. By programming through the tiny controller in SNC12030, user's varied applications including voice section combination, key trigger arrangement, output control, and other logic functions can be easily implemented.

2. FEATURES

- ◆ Single power supply 2.4V – 5.5V
- ◆ 30 seconds voice capacity are provided (@6KHZ sample rate)
- ◆ Built in a 4-bit tiny controller
- ◆ I/O Port
 - Three 4-bit I/O ports P1, P2 and P3 are provided.
 - The driving/sink current of P3.2 & P3.3 is up to 8mA/16mA
 - The IO pins P3.3 can be modulated with 38.5Khz carry signal to implement IR function.
- ◆ 64*4 bits RAM are provided
- ◆ Maximum 16k program ROM is provided
- ◆ 96k*10 shared ROM for voice data and program
- ◆ Readable ROM code data
- ◆ Built in one channel speech synthesizer
- ◆ Adaptive playing speed from 2.5k-20kHz is provided
- ◆ Built in an 8-level volume control Push-Pull Direct Drive circuit output, can directly connected to Speaker for sound output.
- ◆ System clock: 2MHz
- ◆ Event Mark function supported
- ◆ Low Power Reset
- ◆ Watch Dog Timer Supported

3. PIN ASSIGNMENT

Symbol	I/O	Function Description
P10~P13	I/O	I/O port 1: IO
P20~P23	I/O	I/O port 2: IO
P30~P33	I/O	I/O port 3: IO
Rosc	I	Oscillation component connection pin
BUO1	O	Push-Pull output 1
BUO2	O	Push-Pull output 2
RST	I	RST=1 → Reset Chip (Active H)
VDD	I	Positive power supply
GND	I	Negative power supply
Test	I	Test pin

4. Block Diagram

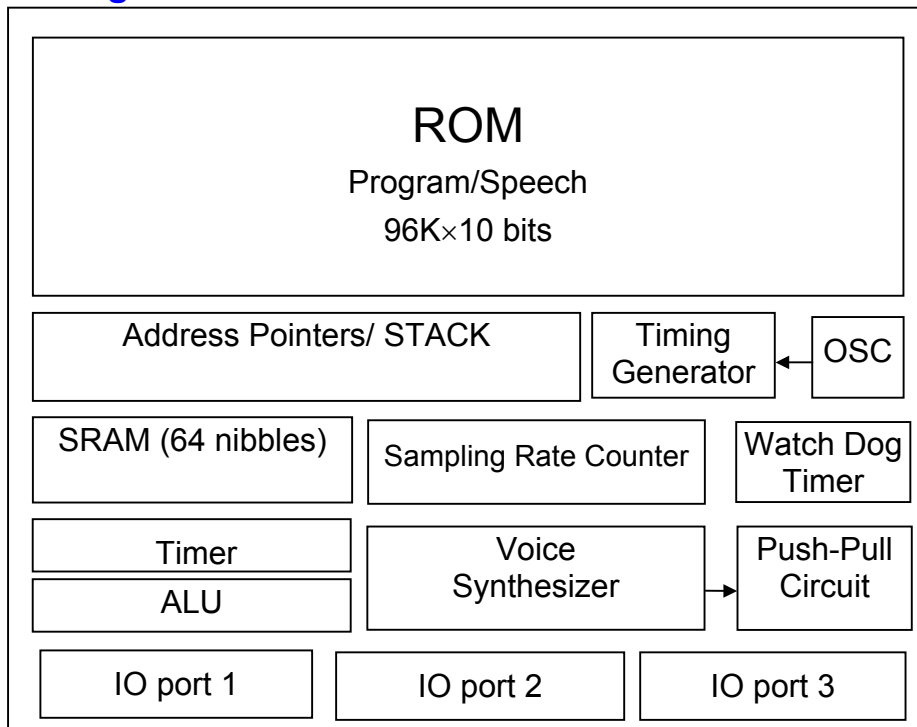

5. FUNCTION DESCRIPTIONS

5.1 Oscillator

SNC12030 accepts RC type oscillator for system clock. The typical circuit diagram for oscillator is listed as follows.

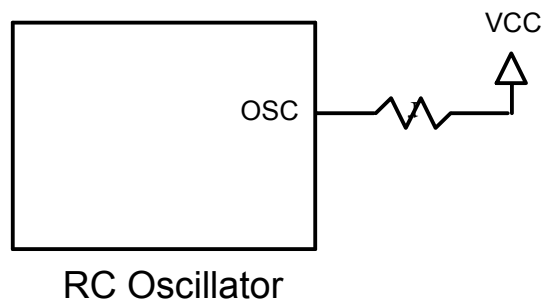

5.2 ROM

SNC12030 contains a substantial 96K words (10-bit) internal ROM, which is shared by program and resource data. Program, voice and data are shared within this same 96K words ROM.

5.3 RAM

SNC12030 contains 64 nibble RAM (64 x 4-bits). The 64 nibble RAM is divided into four pages (page 0 to page 3, 16 nibble RAM on each page). In our programming structure, users can use the instructions, PAGE n (n=0 to 3) to switch and indicate the RAM page. Besides, users can use direct mode, M0 ~ M15 in the data transfer type instructions, to access all 16 nibbles of each page

5.4 Power Down Mode

“End” instruction makes the IC entering into Stop Mode will stop the system clock for power savings (<3uA @VDD=3V and <6uA @VDD=4.5V.) Any valid data transition (L→H or H→L) occurring on any IO pin can be used to start the system clock and return to normal operating mode.

5.5 Sampling Rate Counter

The unique sampling rate counter is designed in voice channel to be able to play diverse voices at different sample playing rates. The playing rate can be adaptively set up among from the wide ranges of 2.5KHz to 20KHz. This architecture yields a high-quality voice synthesis that sounds very close to its original source when played through the same amplifier and speaker circuitry.

5.6 I/O Ports

There are three 4-bit I/O ports P1, P2, and P3. Any I/O can be individually programmed as either input pull low or output. Any valid data transition (H→ L or L→H) of P1, P2 and P3 can reactivate the chip when it is in power-down stage.

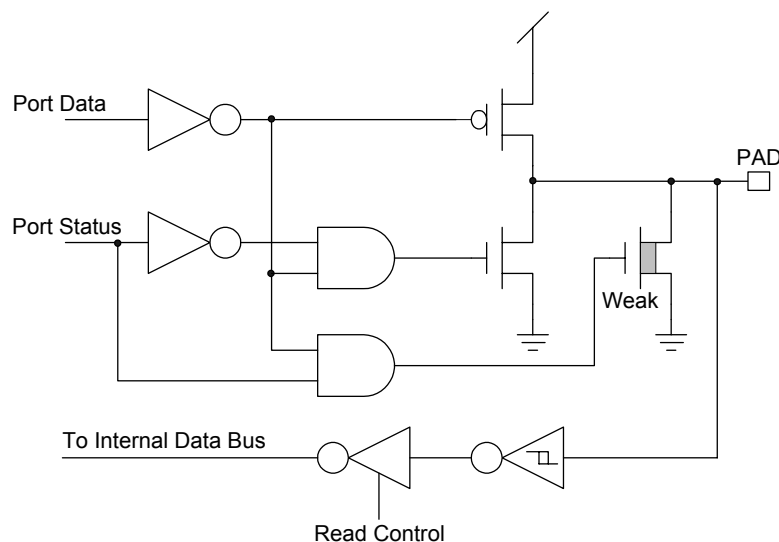

I/O Port Configuration

Note:

- (1) **Weak N-MOS can serve as pull-low resistor.**
- (2) **The driving/sink current of P3.3 & P3.2 is up to 8mA/16mA**

5.7 Push-Pull Output

An 8-level volume control Push-Pull Direct Drive circuit is built-in SNC12030. The maximum resolution of Push-Pull is 7 bits. Two huge output stage circuits are designed in SNC12030. With this advanced circuit, the chip is capable of driving speaker directly without external transistors.

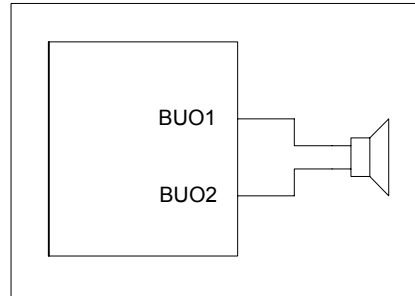

Push-Pull Output

5.8 Watch Dog Timer

SNC12030 built an internal WDT (Watch Dog Timer). This Watchdog timer would issue resets signal to this chip if it is not cleared before reaching terminal count (1sec). The watchdog timer is enabled at reset and cannot be disabled.

5.9 IR Function

P33 can be modulated with 38.5KHz square wave before sent out to P33 pin. The IR signal can be achieved by this modulated signal.

6. ABSOLUTE MAXIMUM RATING

Items	Symbol	Min	Max	Unit.
Supply Voltage	V_{DD-V}	-0.3	6.0	V
Input Voltage	V_{IN}	$V_{SS}-0.3$	$V_{DD}+0.3$	V
Operating Temperature	T_{OP}	0	55.0	°C
Storage Temperature	T_{STG}	-55.0	125.0	°C



7. ELECTRICAL CHARACTERISTICS

Item	Sym.	Min.	Typ.	Max.	Unit	Condition
Operating Voltage	V _{DD}	2.4	3.0	5.5	V	
Standby current	I _{SBY}	-	3.0 5	-	μA	V _{DD} =3V, no load V _{DD} =4.5V, no load
Operating Current	I _{OPR}	-	300	-	μA	V _{DD} =3V, no load
Input current of P1, P2, P3	I _{IH}	-	3.0	-	μA	V _{DD} =3V, V _{IN} =3V
Drive current of P1, P2, P3.0, P3.1	I _{OD}	3	4	-	mA	V _{DD} =3V, V _O =2.4V
Sink Current of P1, P2, P3.0, P3.1	I _{OS}	4	6	-	mA	V _{DD} =3V, V _O =0.4V
Drive current of P3.2, P3.3	I _{OD}	6	8	-	mA	V _{DD} =3V, V _O =2.4V
Sink current of P3.2, P3.3	I _{OS}	10	16	-	mA	V _{DD} =3V, V _O =2.4V
Push-Pull current	I _{PP}	-	70	-	mA	V _{DD} =3V, Output 1K Sin wave.
Push-Pull current	I _{PP}	-	100	-	mA	V _{DD} =4.5V, Output 1K Sin wave.
Oscillation Freq.	F _{OSC}	-	2.0	-	MHz	V _{DD} =3V

8. APPLICATION CIRCUIT

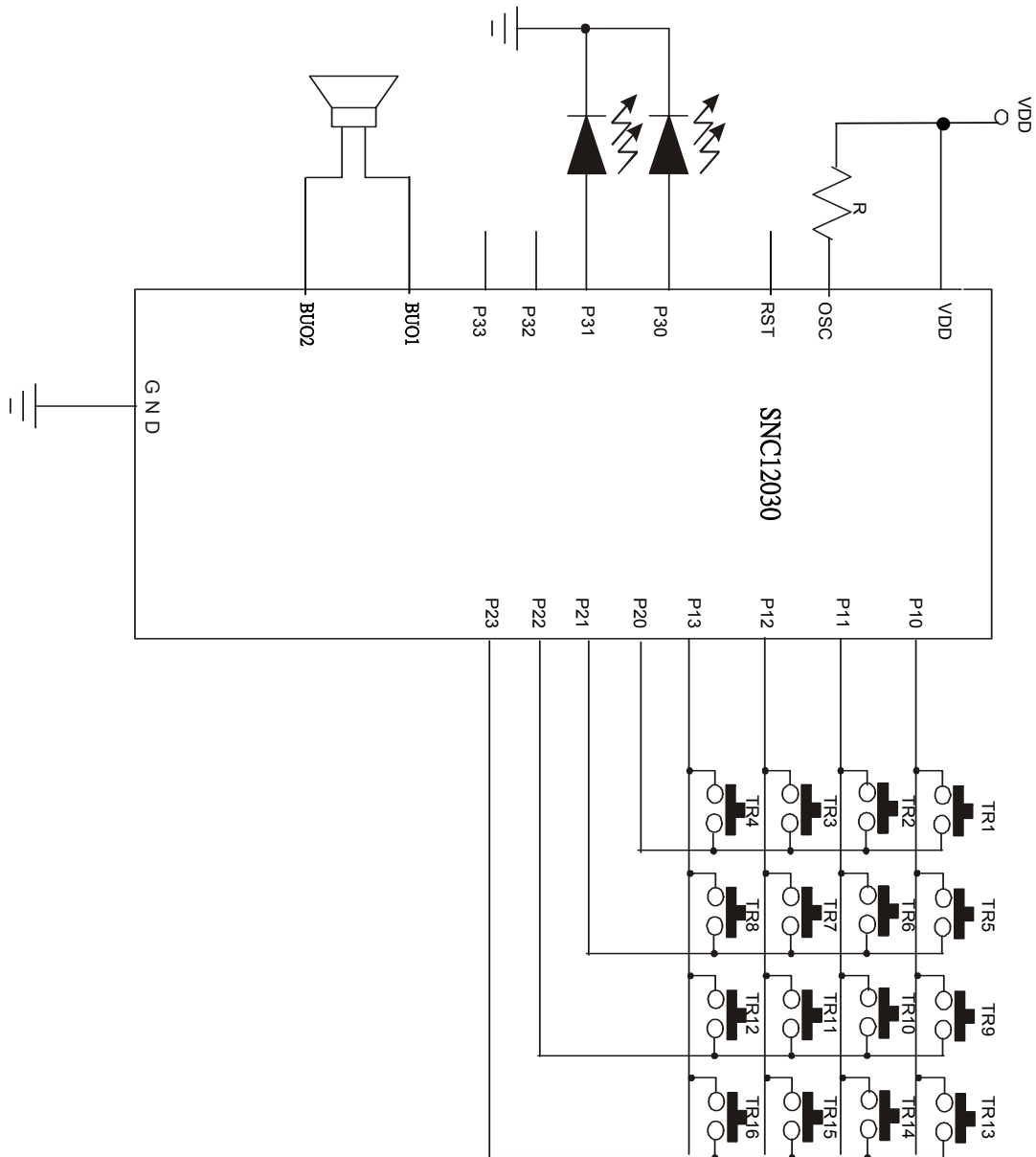

DISCLAIMER

The information appearing in SONiX web pages (“this publication”) is believed to be accurate.

However, this publication could contain technical inaccuracies or typographical errors. The reader should not assume that this publication is error-free or that it will be suitable for any particular purpose. SONiX makes no warranty, express, statutory implied or by description in this publication or other documents which are referenced by or linked to this publication. In no event shall SONiX be liable for any special, incidental, indirect or consequential damages of any kind, or any damages whatsoever, including, without limitation, those resulting from loss of use, data or profits, whether or not advised of the possibility of damage, and on any theory of liability, arising out of or in connection with the use or performance of this publication or other documents which are referenced by or linked to this publication.

This publication was developed for products offered in Taiwan. SONiX may not offer the products discussed in this document in other countries. Information is subject to change without notice. Please contact SONiX or its local representative for information on offerings available. Integrated circuits sold by SONiX are covered by the warranty and patent indemnification provisions stipulated in the terms of sale only. The application circuits illustrated in this document are for reference purposes only. SONiX DISCLAIMS ALL WARRANTIES, INCLUDING THE WARRANTY OF MERCHANTABILITY OR FITNESS FOR ANY PURPOSE. SONiX reserves the right to halt production or alter the specifications and prices, and discontinue marketing the Products listed at any time without notice. Accordingly, the reader is cautioned to verify that the data sheets and other information in this publication are current before placing orders.

Products described herein are intended for use in normal commercial applications. Applications involving unusual environmental or reliability requirements, e.g. military equipment or medical life support equipment, are specifically not recommended without additional processing by SONiX for such application.